

DS-2CE56D8T-IT3Z 2 MP Ultra-Low Light VF Turret Camera



Key Features

- 2 MP high performance CMOS
- Ultra-Low Light
- 1920 × 1080 resolution
- Auto focus, 2.8 mm to 12 mm motorized vari-focal lens
- 120 dB true WDR, 3D DNR
- EXIR 2.0, Smart IR, up to 40 m IR distance
- IP67
- Up the Coax (HIKVISION-C)



Specification

Camera	
Image Sensor	2.0 megapixel progressive scan CMOS
Signal System	PAL/NTSC
Frame Rate	PAL: 1080p@25fps NTSC: 1080p@30fps
Resolution	1920 (H) × 1080 (V)
Min. illumination	Color: 0.005 Lux @ (F1.2, AGC ON), 0 Lux with IR
Shutter Time	PAL: 1/25 s to 1/50, 000 s NTSC: 1/30 s to 1/50, 000 s
Slow Shutter	Max. 16 times
Lens	2.8 mm to 12 mm motorized vari-focal lens
Horizontal Field of View	32.1° to 103°
Lens Mount	Φ14
Day & Night	IR cut filter
Angle Adjustment	Pan: 0° to 360°, Tilt: 0° to 75°, Rotate: 0° to 360°
Synchronization	Internal synchronization
WDR (Wide Dynamic Range)	> 120 dB
Menu	
AGC	Support
Day/Night Mode	Auto/Color/BW (Black and White)
White Balance	ATW/MANUAL
Privacy Mask	ON/OFF, 4 programmable privacy masks
Motion Detection	4 programmable motion areas
Backlight Compensation	WDR/BLC/OFF
3D DNR (Digital Noise Reduction)	Level 1 to 10
Language	English, Chinese
Functions	Brightness, Sharpness, Mirror, Smart IR
Interface	
Video Output	1 HD analog output
General	
Operating Conditions	-40 °C to 60 °C (-40 °F to 140 °F), humidity: 90% or less (non-condensation)
Power Supply	12 VDC ±25% -A: 12 VDC ±25%, 24 VDC ±25%
Power Consumption	Max. 7.5 W
Ingress Protection	IP67
Material	Metal & Plastic
IR Range	Up to 40 m
Communication	Up the coax, Protocol: HIKVISION-C (TVI output)
Dimensions	134.3 mm × 123.9 mm × 111.4 mm (5.29" × 4.88" × 4.39")
Weight	Approx. 750 g (1.57 lb.)

Order Models

DS-2CE56D8T-IT3Z

Dimension

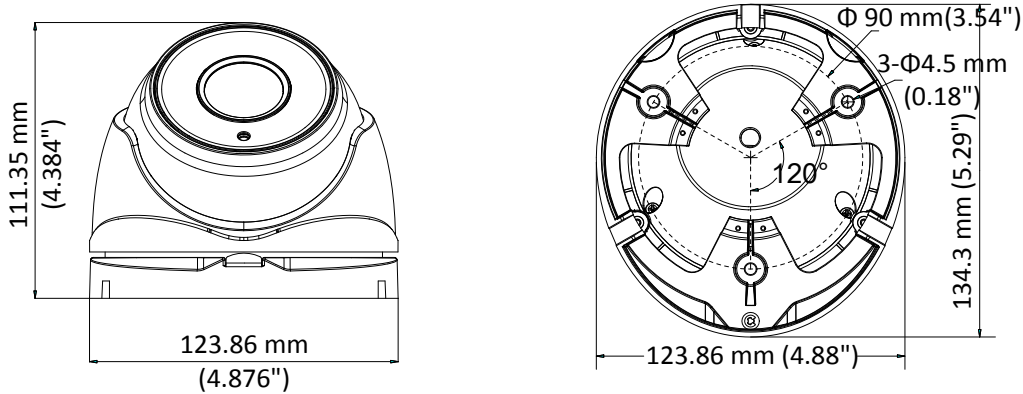

Accessory



DS-1273ZJ-130-TRL
Wall Mounting Bracket



DS-1275ZJ-SUS
Vertical Pole Mounting Bracket



DS-1276ZJ-SUS
Corner Mounting Bracket



DS-1280ZJ-M
Junction Box



DS-1281ZJ-M
Inclined Ceiling Mounting Bracket



DS-1H18
Video Balun

Distributed by



Headquarters

No.555 Qianmo Road, Binjiang District,
Hangzhou 310051, China
T +86-571-8807-5998
overseasbusiness@hikvision.com

Hikvision USA
T +1-909-895-0400
sales.usa@hikvision.com

Hikvision Europe
T +31-23-55-42-770
info.eu@hikvision.com

Hikvision Middle East
T +971-4-8816086
salesme@hikvision.com

Hikvision Russia
T +7-495-669-67-99
saleru@hikvision.com

Hikvision India
T +91-22-28469900
sales@pramahikvision.com

Hikvision Italy
T +39-0438-6902
info.it@hikvision.com

Hikvision France
T +33(0)1-85-330-450
info.fr@hikvision.com

Hikvision Spain
T +34-91-737-16-55
info.es@hikvision.com

Hikvision Poland
T +48-22-460-01-50
poland@hikvision.com

Hikvision UK
T +01628-902140
support.uk@hikvision.com

Hikvision Singapore
T +65-6684-4718
sg@hikvision.com

Hikvision Oceania
T +61-2-8599-4233
salesau@hikvision.com

Hikvision Canada
T +1-909-895-0400
sales.usa@hikvision.com

Hikvision Korea
T +82-31-731-8841
sales.korea@hikvision.com

Hikvision Brazil
T +55 11 3318-0050
Latam.support@hikvision.com

Hikvision Africa
T +27 (0) 0351172
sale.africa@hikvision.com

Hikvision Hong Kong
T +852-2151-1761